

**WIRE WOUND RESISTORS
SILICONE COATED TYPE**

VHIA

SERIES

**HIGH SURFACE TEMPERATURE
Power Silicone "Thermo Coat"
Wire Wound Resistors**

Industrial / Professional Applications

- Flame retardant coating compatible with UL standards
- Small Size : Power Ratio.
- 0.5W to 25 Watts (at 40°C)
- Tolerances as close as 1%.
 - R01 to 150K.
- TCR as low as +20ppm/°C available depending on application and resistance value.
- Pulse applications as per IEC 61000-4-5.

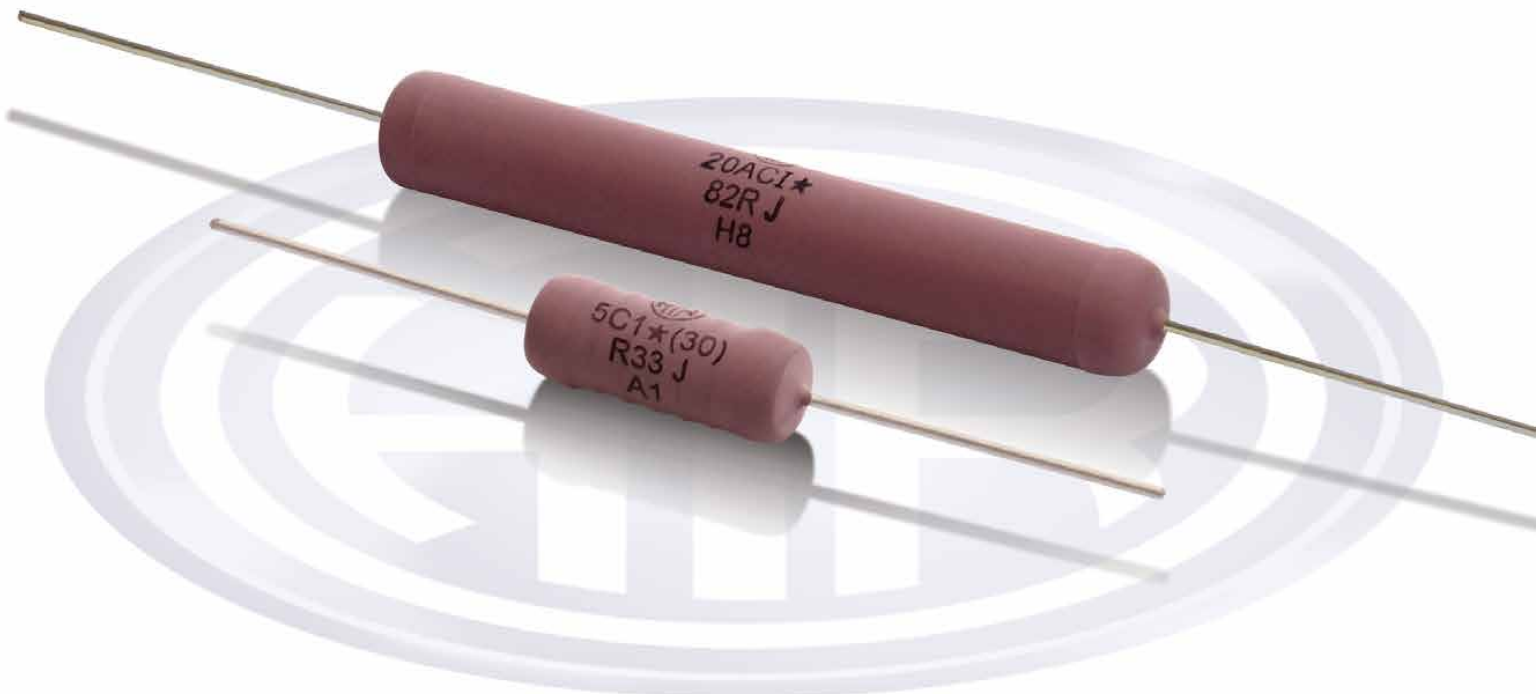



WIRE WOUND
RESISTORS
SILICONE
COATED TYPE
VHIA

PHYSICAL CONFIGURATION

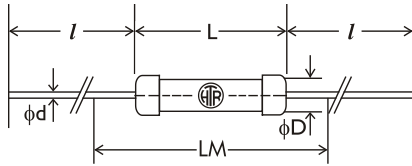

TYPE	POWER RATING at 40°C (Ambient)	DIMENSIONS (mm)					RESISTANCE RANGE		TYPICAL WT. PER PC (gms)
		L (max)	∅ D (max)	l ±1.5	d ±0.05	⊕ LM ±1	min	max	
0.5 MC	0.5W	7.0	2.7	38	0.5	30	R10	1K6	0.21
1 MC	1W	10.9	3.2	38	0.5	30	R10	4K0	0.36
1 AC	1W	11.50	4.5	38	0.8	35	R01	6K2	0.75
2.5 C	2.5W	13.0	5.5	38	0.8	35	R01	10K	1.2
2.5 C1	2.5W	13.0	5.5	38	1.0	35	R01	10K	1.8
3 MC	3W	12.5	5.1	38	0.8	35	R01	7K6	0.8
3 C	3W	15.2	6.0	38	0.8	40	R01	14K	1.2
4 C	4W	16.2	6.9	38	1.0	40	R01	15K	2.0
4 AC	4W	16.5	5.5	38	0.8	40	R01	11K	1.25
4 MC	4W	13.2	5.5	38	0.8	35	R01	10K	1.0
4 CL	4W	23.0	7.2	38	0.8	45	R01	33K	2.9
5 AC	5W	17.5	7.5	38	0.8	40	R01	29K	1.8
5 C1	5W	23.5	8.7	38	1.0	45	R01	47K	3.6
5 C	5W	23.5	8.7	38	0.8	45	R01	47K	3.1
7 AC	7W	25.5	7.5	38	0.8	45	R01	39K	3.6
7 C1	7W	32.5	9.5	38	1.0	55	R10	68K	5.3
10 AC	10W	44.0	8.5	38	0.8	65	R10	88K	6.9
10 C1	10W	44.0	9.8	38	1.0	65	R10	100K	8.3
10 C	10W	44.0	9.8	38	0.8	65	R10	100K	7.3
13 C1	13W	47.0	10.0	38	1.0	70	R10	100K	7.6
15AC	15W	50.0	10.0	38	0.8	70	R10	100K	8.2
15AC1	15W	50.0	10.0	38	1.0	70	R10	100K	8.6
20AC	20W	67.0	10.0	38	0.8	90	R10	120K	11.5
20AC1	20W	67.0	10.0	38	1.0	90	R10	120K	12.0
25AC1	25W	73.0	10.0	38	1.0	95	1R0	150K	13.5

* For non-inductive types and for resistance values <1R0, +0.8mm allowed.

▲ Coating overflow on each lead not to exceed half of 'D'.

▼ For resistance values less than R10 and tolerance less than ±2%, please measure resistance over centered length LM.

● Special Resistance values available on request.

Note :

1. The standard terminals in this series is tinned Copper Weld®. 2. For Pulse capability please refer to Electrical data / characteristics section.

NON-INDUCTIVE RESISTORS

Low inductance Aryton - Perry winding type resistors are available in this series.

For non-inductive types reduce maximum resistance values shown to 50% and the continuous working voltage to 70%.

PRE-FORMED LEADS

The resistors terminations can be bent and cut as per requirements for quick PCB mounting. Please send detailed drawings of the type of preforming required.

TAPING

Taping : Types 0.5MC, 1MC, 1AC, 4C, 3C, 3MC, 4MC, 2.5C1, 2.5C, 5C1, 5AC, 5C, 7AC, 4CL, 7C1, 10AC, 10C, 10C1, 15AC, 15AC1 are available in taped form. Please refer Tape / Ammo specifications. Tape / Reel on request.



DERATING CURVE

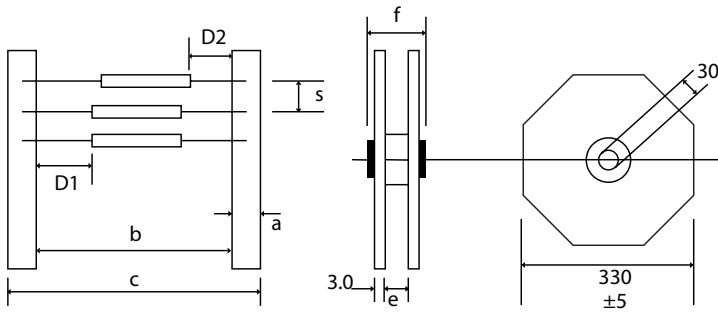
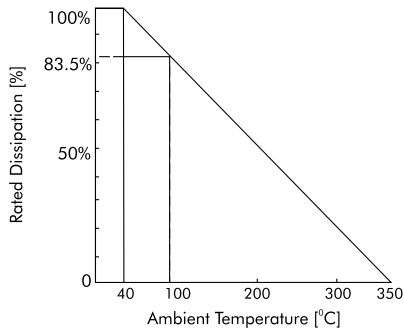

Where

- a' stands for width of the tape
- b' stands for inner distance between two tapes
- e' stands for the inner distance of the reel
- f' stands for the total width of the reel
- S' stands for the pitch between resistors

Note

The maximum difference between D1 & D2 is 1.40 mm | All dimensions stated below are in mm
Dimensions 'e' & 'f' are given as approximate guidelines only

Note: Dimension are applied for Tape A & Ammo/Tape a& Real

Table 1.2 :

TYPE	POWER RATING at 40°C (Ambient)	DIMENSIONS (mm)					RESISTANCE RANGE		TYPICAL WT. PER PC (gms)
		a ±1	s ±0.05	b ±0.05	c ±2	10x S±2	min	max	
0.5 MC	0.5W	6	10	52	64	100	R10	1K6	0.21
1 MC	1W	6	10	52	64	100	R10	4K0	0.36
1 AC	1W	6	10	52	64	100	R01	6K2	0.75
2.5 C	2.5W	6	10	63	75	100	R01	10K	1.2
2.5 C1	2.5W	6	10	63	75	100	R01	10K	1.8
3 MC	3W	6	10	63	75	100	R01	7K6	0.8
3 C	3W	6	10	63	75	100	R01	14K	1.2
4 C	4W	6	10	63	75	100	R01	15K	2.0
4 AC	4W	6	10	63	75	100	R01	11K	1.25
4 MC	4W	6	10	63	75	100	R01	10K	1.0
4 CL	4W	6	10	74	86	100	R01	33K	2.9
5 AC	5W	6	10	74	86	100	R01	29K	1.8
5 C1	5W	6	10	74	86	100	R01	47K	3.6
5 C	5W	6	10	74	86	100	R01	47K	3.1
7 AC	7W	6	10	74	86	100	R01	39K	3.6
7 C1	7W	6	15	74	86	150	R10	68K	5.3
10 AC	10W	6	15	79	91	150	R10	88K	6.9
10 C1	10W	6	15	79	91	150	R10	100K	8.3
10 C	10W	6	15	79	91	150	R10	100K	7.3
13 C1	13W	6	15	90	102	150	R10	100K	7.6
15AC	15W	6	15	90	102	150	R10	100K	8.2
15AC1	15W	6	15	90	102	150	R10	100K	8.6



WIRE WOUND
RESISTORS
SILICONE
COATED TYPE
VHIA

PACKING CONFIGURATION

HTR TYPE	BULK PACKING (For Dimension Refer to Table 1.1) Number of Pieces	TAPE & AMMO PACKING (For Dimension Refer to Table 1.2) Number of Pieces	TAPE & REEL PACKING (For Dimension Refer to Table 1.2) Number of Pieces
0.5 MC	500	1000	2500
1 MC	500	1000	2500
1 AC	500	1000	2500
2.5 C	500	750	1500
2.5 C1	500	750	1500
3 MC	500	750	1500
3 C	500	750	1250
4 C	500	750	1250
4 AC	500	750	1250
4 MC	500	750	1500
4 CL	600	300	800
5 AC	500	300	800
5 C1	500	300	800
5 C	500	300	800
7 AC	200	300	800
7 C1	125	175	450
10 AC	100	175	450
10 C1	100	175	450
10 C	100	175	450
13 C1	100	175	450
15 AC	100	175	450
15 AC1	100	175	450
20 AC	100	N.A.	N.A.
20 AC1	100	N.A.	N.A.
25AC1	100	N.A.	N.A.

ELECTRICAL DATA / CHARACTERISTICS

PARAMETER/PERFORMANCE TEST & TEST METHOD	PERFORMANCE REQUIREMENTS
Rated Ambient Temperature down to zero at 350°C - [Refer Derating curve above].	Full Power dissipation at 40°C and linearly derated
Voltage Rating / Limiting Voltage / Max Working Voltage	$V = \sqrt{PxR}$
Dielectric Withstanding Voltage / Voltage Proof [Test method no. 301 of MIL 202F] - Based on limiting voltage x 2 or 500V whichever is applicable.	Max. $\Delta R \pm (1\% + R05)$. No flashover, mechanical damage, arcing or insulation breakdown.
Insulation Resistance [Test method no. 302 of MIL 202F]	> 1000M (dry) > 100M (wet)
Short Time Overload [Test Method - 5 secs at 5 times rated power for 3 watts and smaller; 5 secs at 10 times rated power for 4 watts and larger]	Max. $\Delta R \pm (2\% + R05)$
Resistance Tolerances Available	$\pm 10\%[K]; \pm 5\%[J]; \pm 3\%[H]; \pm 2\%[G]; \pm 1\%[F]$

Resistor Temperature rise as a function of applied power

[See graph displayed]

The graph provided is general in nature and reflects temperature rise of a few selected types for the general guidance of the design engineer. Exact reading for any particular HTR type and specific resistance value can be obtained from factory on request.

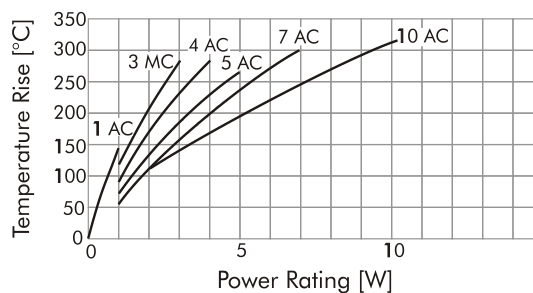



WIRE WOUND
RESISTORS
SILICONE
COATED TYPE
VHIA

Pulse Capability :

For the design engineer HTR has selected a few types and provided below, vital data in the form of charts / graphs which illustrate two important characteristics of the pulse version of these HTR types.

Pulse On Regular Basis - The maximum allowable peak pulse power (W) as a function of pulse duration (T) in seconds. (Repetitive Pulse)
- t_p repetition time of the pulses / t_i - impulse time-duration of pulse.

1 AC

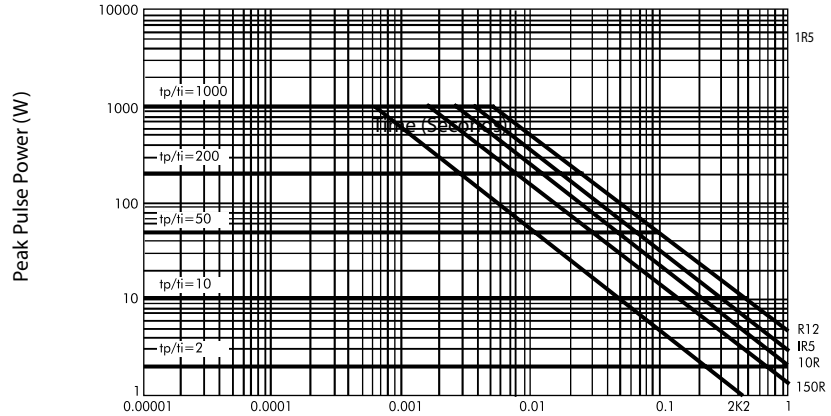

3 MC

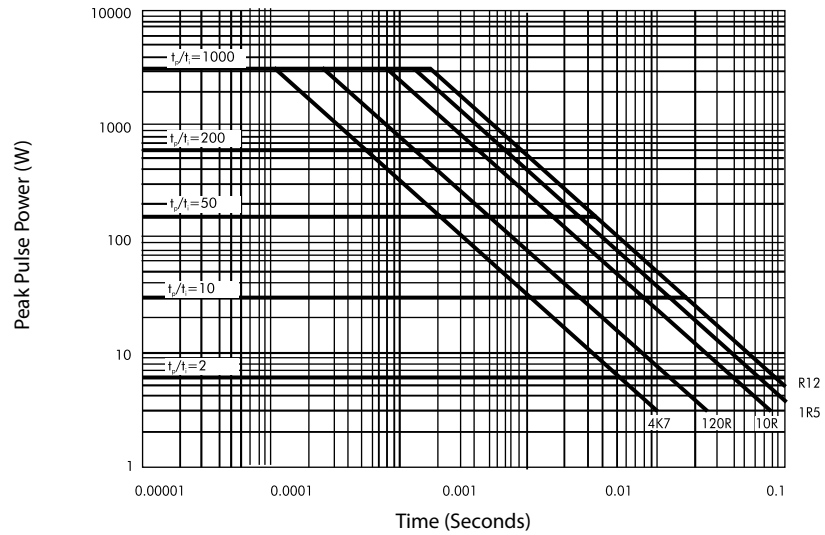

4 AC

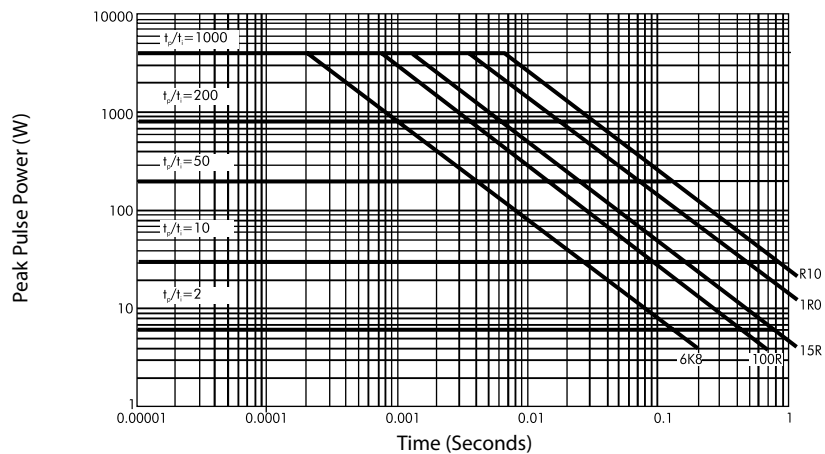



WIRE WOUND
RESISTORS
SILICONE
COATED TYPE
VHIA

5 AC

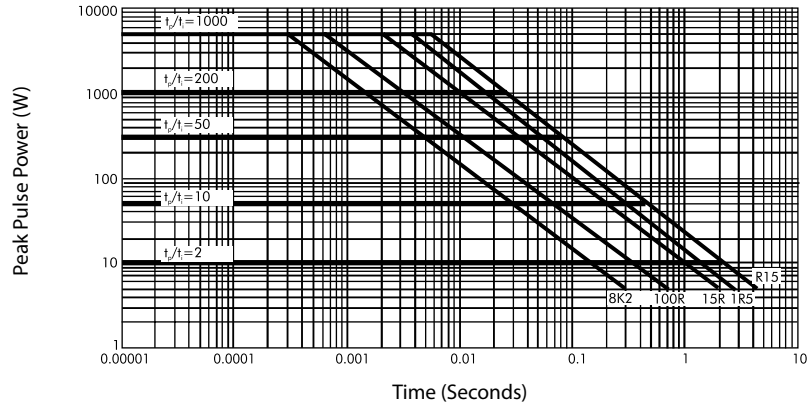

7 AC

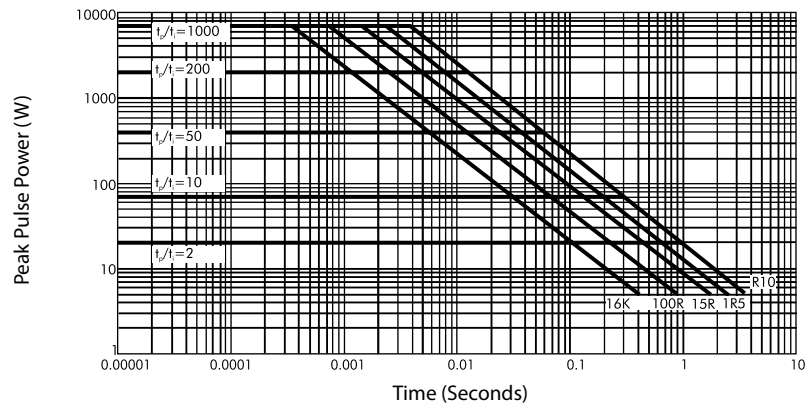

10 AC

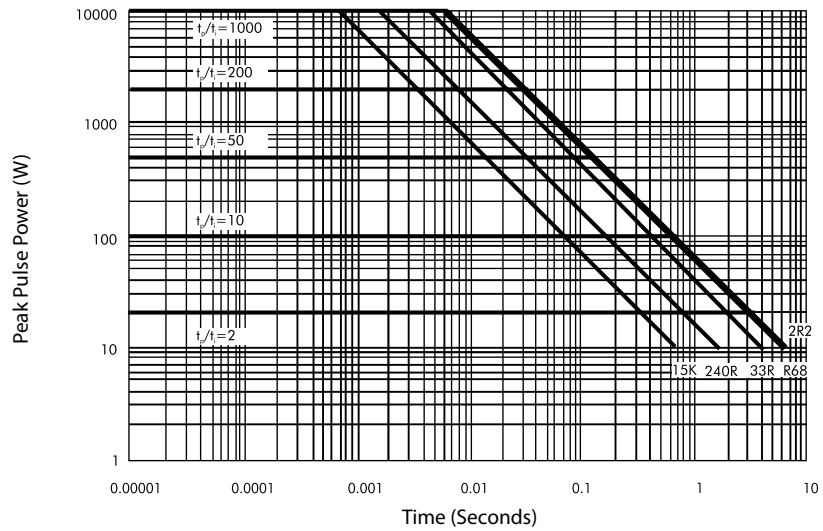



WIRE WOUND
RESISTORS
SILICONE
COATED TYPE
VHIA

Pulse Capability - Energy (J) as a function of R (Ω) (Single Pulse)

1 AC

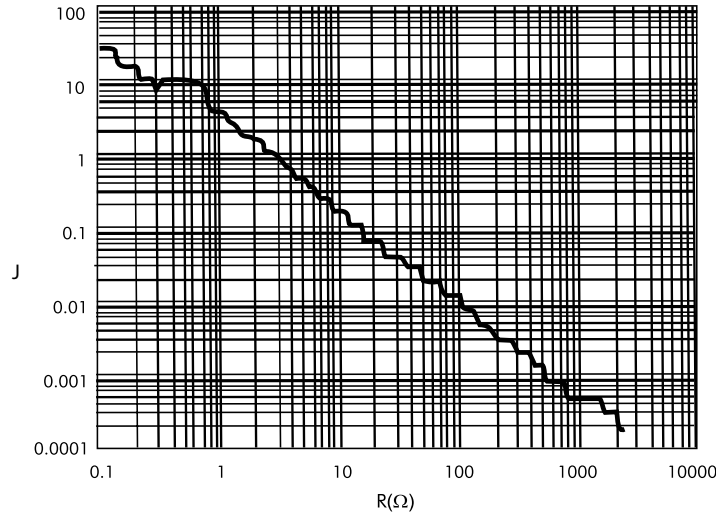

3 MC

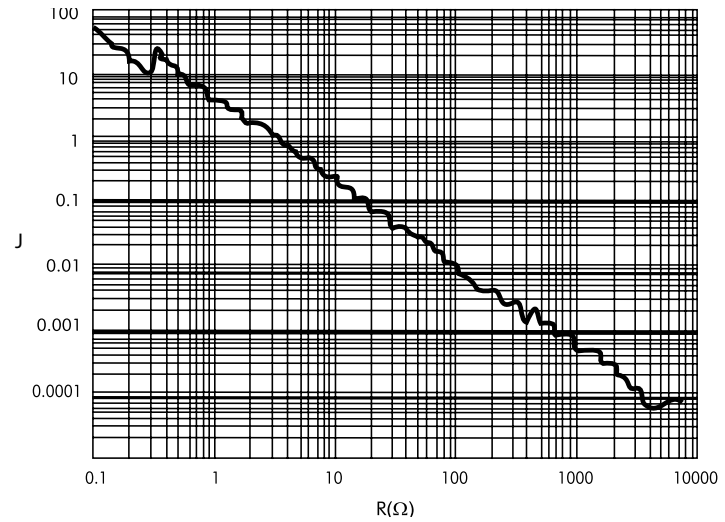

4 AC

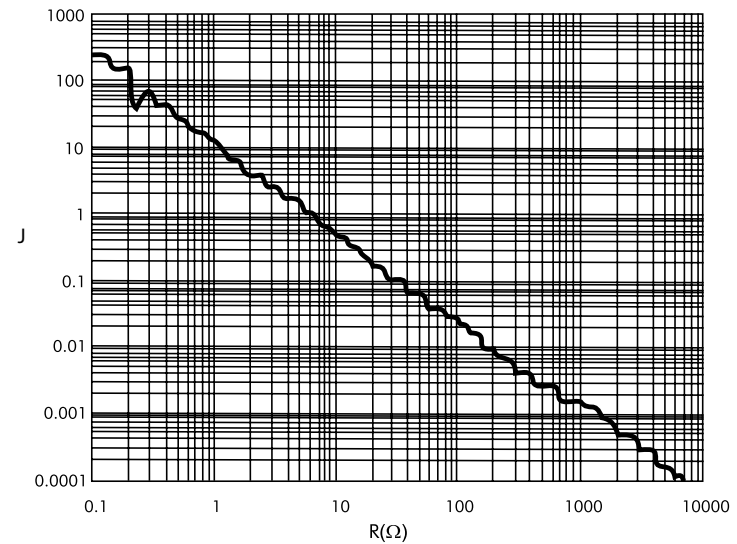



WIRE WOUND
RESISTORS
SILICONE
COATED TYPE
VHIA

5 AC J

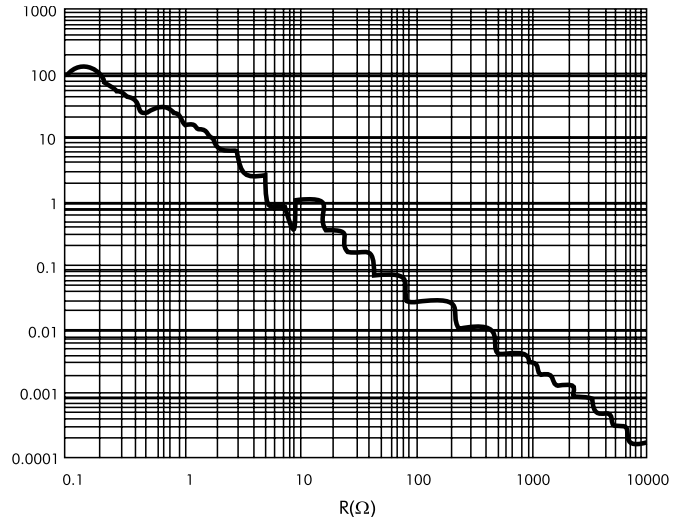

7AC J

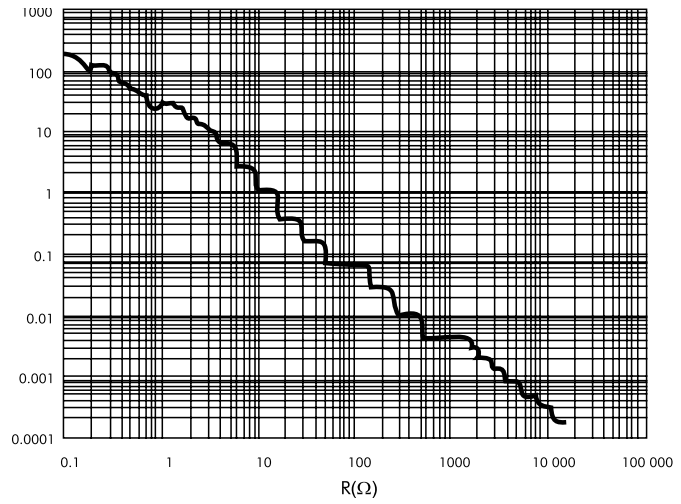

10 AC J

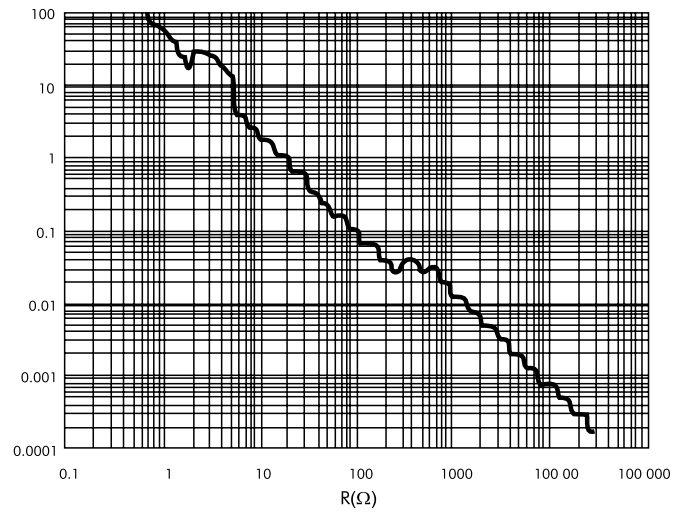



WIRE WOUND
RESISTORS
SILICONE
COATED TYPE
VHIA

The design engineer is cautioned that these graphs are general in nature solely provided for his general guidance for selection of the required power rating and resistance of the device to be used for circuit protection. It is essential that this must be validated in actual trials and HTR will be pleased to provide the necessary samples for validation and homologation.

Please suffix the HTR type with the alphabet 'I' when a pulse version of the device is required.

ENVIRONMENTAL SPECIFICATIONS

PARAMETER/PERFORMANCE TEST&TEST METHOD	PERFORMANCE REQUIREMENTS
Temperature Co-efficient [Test method 304 of MIL 202F] [TCR figures given are based on the usage of normally effective resistance elements and can be significantly lowered on request]	$\pm 120\text{ppm}/^{\circ}\text{C}$ for $< R10$; $\pm 80\text{ppm}/^{\circ}\text{C}$ for $< 1R0$; $\pm 60\text{ppm}/^{\circ}\text{C}$ for $< 100R$; $\pm 90\text{ppm}/^{\circ}\text{C}$ or $\pm 30\text{ppm}/^{\circ}\text{C}$ for $> 100R$, depending on wire selected
Damp Heat (Steady State) [Test method no. 103B of MIL 202F and test condition 'D']	Max. $\Delta R \pm [5\% + R05]$ No mechanical damage.
Load Life [Test method no. 108A of MIL 202F]	Max. $\Delta R \pm [5\% + R05]$ No mechanical damage

MECHANICAL SPECIFICATIONS

PARAMETER/PERFORMANCE TEST&TEST METHOD	PERFORMANCE REQUIREMENTS
Pull test / Robustness of Terminations [Force supplied from 2 to 4.5 Kgs depending on size]	No mechanical damage
Solderability [Test method no. 208F of MIL 202F]	Continuous and satisfactory $\Delta R < \pm [1\% + R05]$

ORDERING INFORMATION

Series	Type	Packing	Resistance Value	Tolerance
VHIA	5AC / 5AC*	Bulk 5AC / 5AC* Tape & Ammo 5ACT / 5AC*T Tape & Reel 5ACTR / 5AC*TR	100R	J

1. RoHS version - 0.5 MC *
2. Non inductive winding - N 0.5 MC
3. Impulse type - 0.5 MC I
4. Tape & Ammo pack - 0.5 MCT
5. Tape & Reel pack - 0.5 MC TR

Item code will differ from ordering information.